

M12 male 0° / M12 female 0°

PUR 5x0.34 bk UL/CSA+drag chain 0,15m

Male straight – female straight

M12 – M12, 5-pole

A-coded

Art-No. 7005 - M12 Lite - (plastic hexagonal screw) on request

Plastic housings with good resistance against chemicals and oils.

The resistance to aggressive media should be individually tested for your application. Further details on request.

Further cable lengths on request.

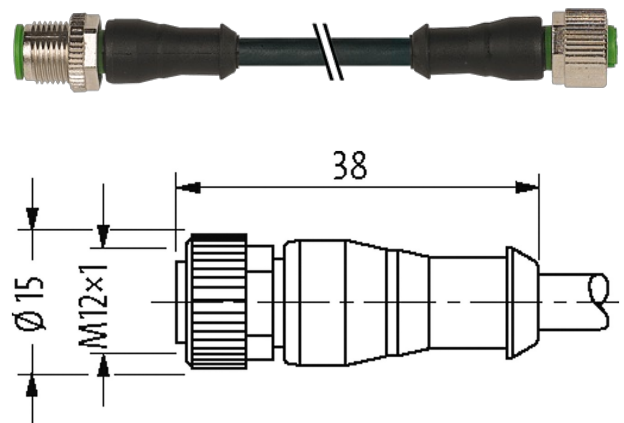
[Link to Product](#)**Illustration**

Product may differ from Image

Approvals

* only for products with UL/CSA approved cable

cCSAus

Form

Form 40041

General data

| | |
|-------------------|--|
| Standards | DIN EN 61076-2-101 (M12) |
| Pollution Degree | 3 |
| Temperature range | -25...+85 °C, depending on cable quality |

Cables

| | |
|----------------------------|---------------------------|
| No./diameter of wires | 5 x 0.34 mm ² |
| Wire isolation | PP (br, wh, bl, bk, gnye) |
| C-track properties | 10 Mio. |
| Material (jacket) | PUR (UL/CSA) |
| Outer Ø | 4.8 mm ±5% |
| Bend radius (moving) | 10 x outer Ø |
| Temperature range (fixed) | -40...+80 °C |
| Temperature range (mobile) | -25...+80 °C |
| Cable identification | 635 |

| | |
|-------------------------------------|--|
| Cable Type | 3 (PUR) |
| Approval (cable) | cURus (AWM-Style 20549/10493); CE conform |
| Cable weight [g/m] | 41,80 |
| Material (wire) | Cu wire, bare |
| Resistor (core) | max. 57 Ω /km (20 °C) |
| Single wire \varnothing (core) | 0.1 mm |
| Construction (core) | 42× 0.1 mm (multi-strand wire class 6) |
| Diameter (core) | 5× 0.34 mm ² |
| AWG | similar to AWG 22 |
| Material (wire isolation) | PP |
| Material property (wire isolation) | CFC-, halogen-, cadmium-, silicone- and lead-free |
| Shore hardness (wire isolation) | 70 ±5 D |
| Wire- \varnothing incl. isolation | 1.25 mm ±5% |
| Color/numbering of wires | br, bk, bl, wh, gnye longitudinally striped |
| Stranding combination | 5 wires twisted around central filler |
| Shield | no |
| Material (jacket) | PUR |
| Material property (jacket) | CFC-, halogen-, cadmium-, silicone- and lead-free, matt, low-adhesion, machine easy to process, abrasion-resistant, hydrolysis and microbial resistant |
| Shore hardness (jacket) | 90 ±5 A |
| Outer- \varnothing (jacket) | 4.8 mm ±5% |
| Color (jacket) | black |
| chemical resistance | good resistance to oil, gasoline and chemicals (EN 60811-404) |
| thermal resistance | flame retardant UL 1581 VW1 / CSA FT1 / IEC 60332-1, IEC 60332-2-2 |
| Nominal voltage | 300 V AC |
| Test voltage | 2500 V AC |
| Current load capacity | to DIN VDE 0298-4 |
| Temperature range (fixed) | -40...+80 °C, (+90 °C at max. 10 000 operating hours) |
| Temperature range (mobile) | -25...+80 °C, (+90 °C at max. 10 000 operating hours) |
| Bend radius (fixed) | 5× outer \varnothing |
| Bend radius (moving) | 10× outer \varnothing |
| No. of bending cycles (C-track) | max. 10 Mio. (25 °C) |
| Travel speed (C-track) | max. 3 m/s |
| Acceleration (C-track) | max. 10 m/s ² |
| Torsion stress | ±180°/m |
| No. of torsion cycles | max. 2 Mio. (25 °C) |
| Torsion speed | 35 cycles/min |
| Jacket Color | black |

Technical Data

| | |
|------------------------------------|--|
| Operating voltage | max. 125 V AC/DC |
| Operating voltage (only UL listed) | max. 30 V AC/DC |
| Rated surge voltage | 1.5 kV |
| Operating current per contact | max. 4 A |
| Material group | IEC 60664-1, category I |
| Coding | A-coded |
| Locking of ports | Screw thread (M12×1 mm) recommended torque 0.6 Nm, self-securing |
| Compression gland | M12 (SW13) |
| Protection | IP65, IP66K, IP67 inserted and tightened (EN 60529) |
| Locking material | Zinc die casting, matte nickel plated |

| | |
|---|-------|
| Material | PUR |
| suitable for corrugated tube (internal Ø) | 10 mm |

Commercial data

| | |
|-----------------------|---------------|
| country of origin | CZ |
| customs tariff number | 85444290 |
| EAN | 4048879181549 |
| eClass | 27279218 |
| Packaging unit | 1 |

Sketch

(* for cable type 126, 732, 219, 619)

Male

Female



Product may differ from Image